



# Hera M200

Range Hood Control Unit

## USER MANUAL



---

Manufacturer:

Phone:

Fax:

E-Mail:

Web:

Document Version:

Hardware Version:

Yazılım Versiyonu:

---

# TABLE OF CONTENTS

---

## 1. GENERAL FEATURES

1.1. Product Specifications .....	4
1.2. Buttons and Their Functions .....	5

## 2. USAGE OF COOKER HOOD .....

6

## 3. USAGE OF TIMER .....

6

## 4. USAGE OF LIGHT .....

7

## 5. 3D BOARD CASE VISUALS .....

8

## 6. ELECTRICAL WIRING DIAGRAM .....

9

# 1. GENERAL FEATURES

---

Hera M200 is a touch controlled, user-friendly cooker hood control unit with timer feature.

With the touch buttons and LED indicators, it combines the functionality with style.

## 1.1. Product Specifications

- Touch buttons with LED indicator
- 3 level settings
- Timer feature for 15, 30, 45 minute
- Supply voltage 230V-50/60 Hz

## 1.2. Buttons and Their Functions

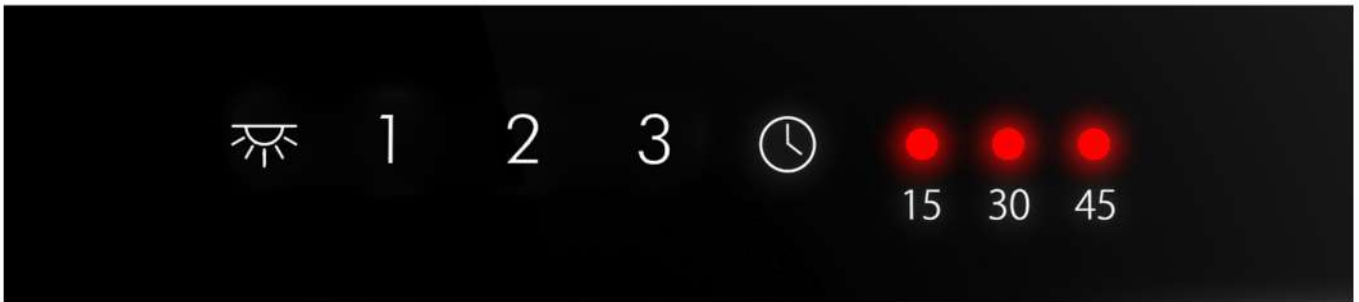

Turns on/off the light



Runs the hood motor at low level



Runs the hood motor at medium level



Runs the hood motor at high level



Turns on/off and adjust the timer

## 2. USAGE of COOKER HOOD

---

To operate the hood manually, the hood is operated by pressing one of the “ 1 ”, “ 2 ” or “ 3 ” buttons according to the desired traction power level. For the lowest level “ 1 ”, for medium level “ 2 ”, for high level “ 3 ” button is used. At which level the hood is operating, the indicator led of that level button stays on. In order to pass from one level to the next, the button of the level you want to pass is pressed. To turn off the hood, the level button is pressed at which level it is operating.

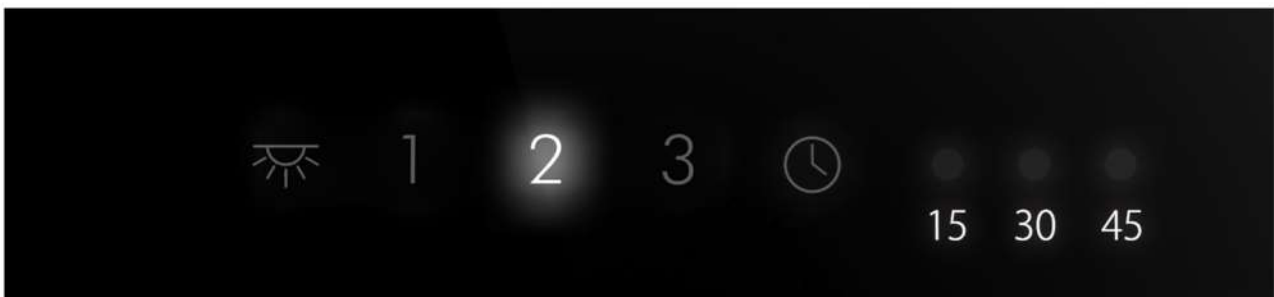

## 3. USAGE of TIMER

---

There is a timer in the hood control unit that allows the hood to be turned off after a certain period of time. With the timer, the hood can be set to turn off after 15, 30 or 45 minutes.

To activate the timer, the hood is first started at any level. Then, the timer is started by pressing the “ ⌚ ” button. It is set to 15 minutes when pressed for the first time, 30 minutes when pressed for the second time, and 45 minutes when pressed for the third time. For which time the timer is set, the indicator led of that time turns on. At the end of the set time, the hood stops working.

To turn off the timer, the “ ⌚ ” button is pressed several times and the timer indicator light is turned off.

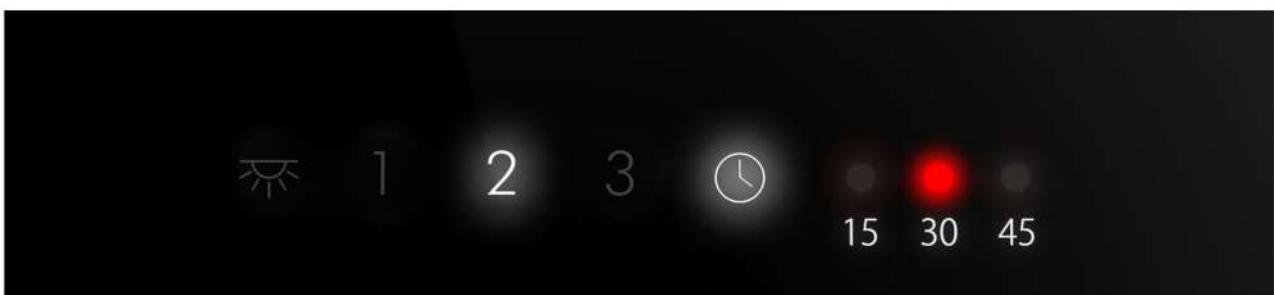

## 4. USAGE of LIGHT

---

The hood lighting lamp can be switched on and off independently of the use of the hood.

To turn the lighting lamp on or off, the “” button is pressed while the hood is running or not.

The light indicator led also stays on when the light is on.

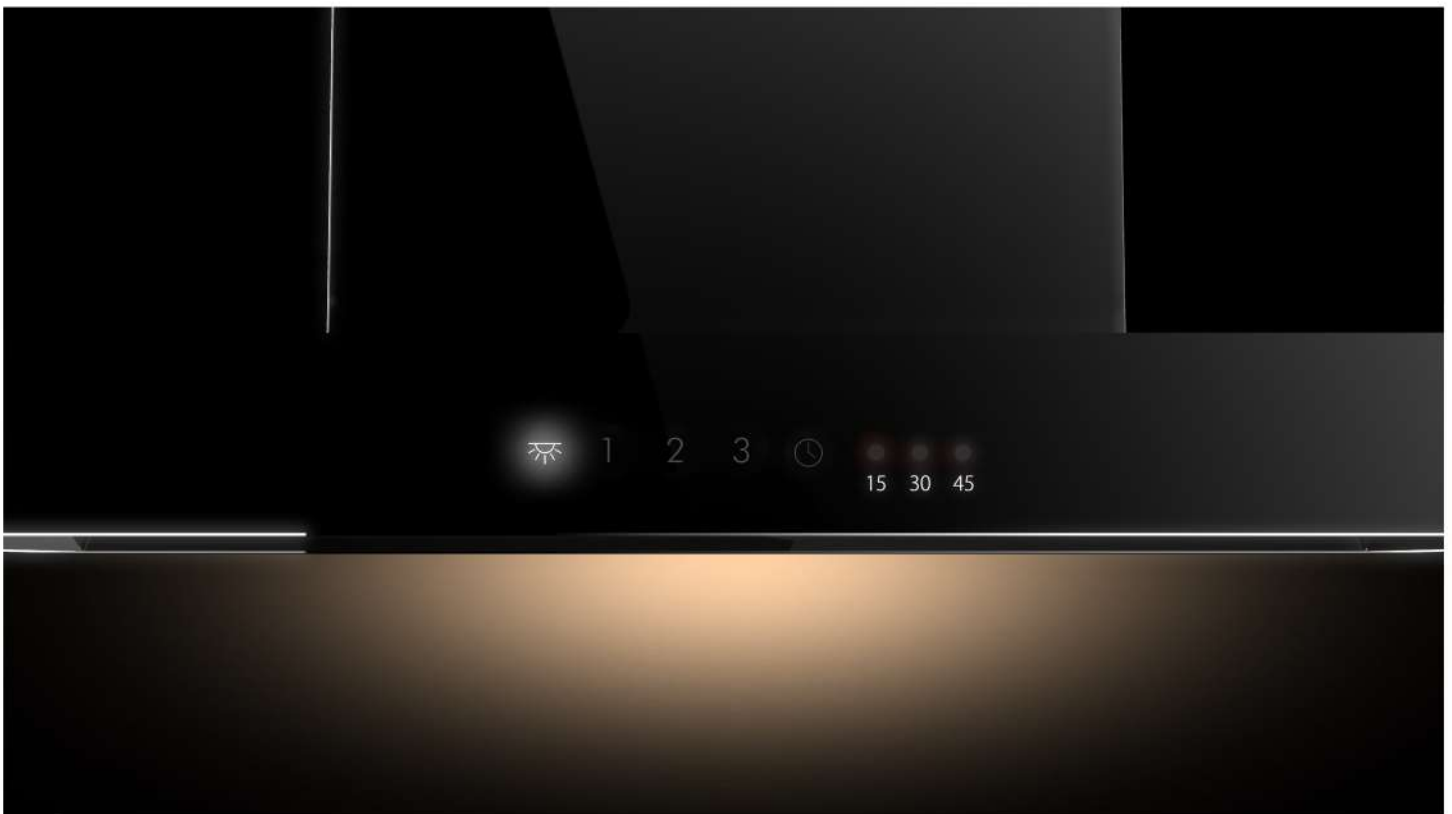

## 5. 3D BOARD CASE VISUALS

---

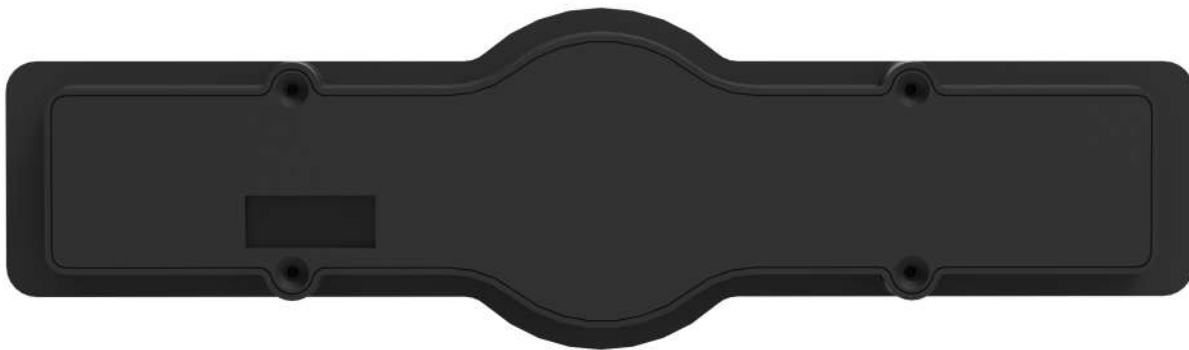
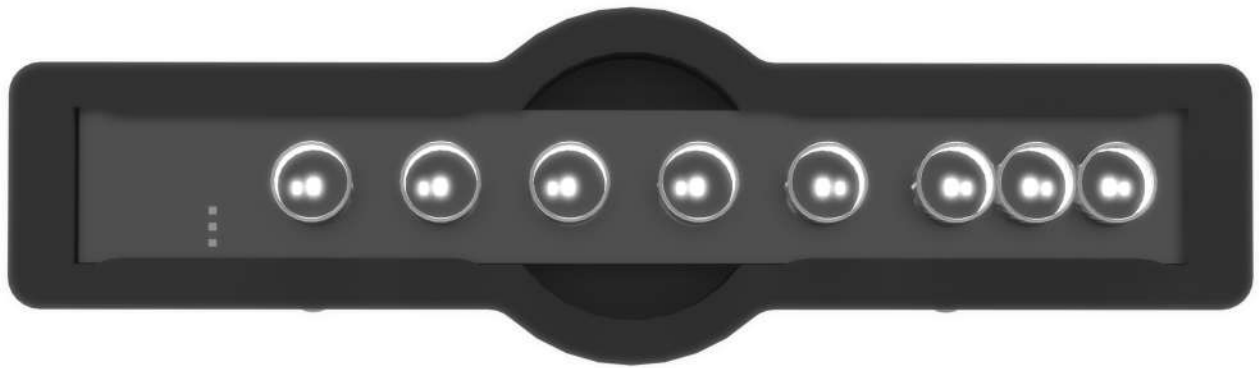



# 6. ELECTRICAL WIRING DIAGRAM

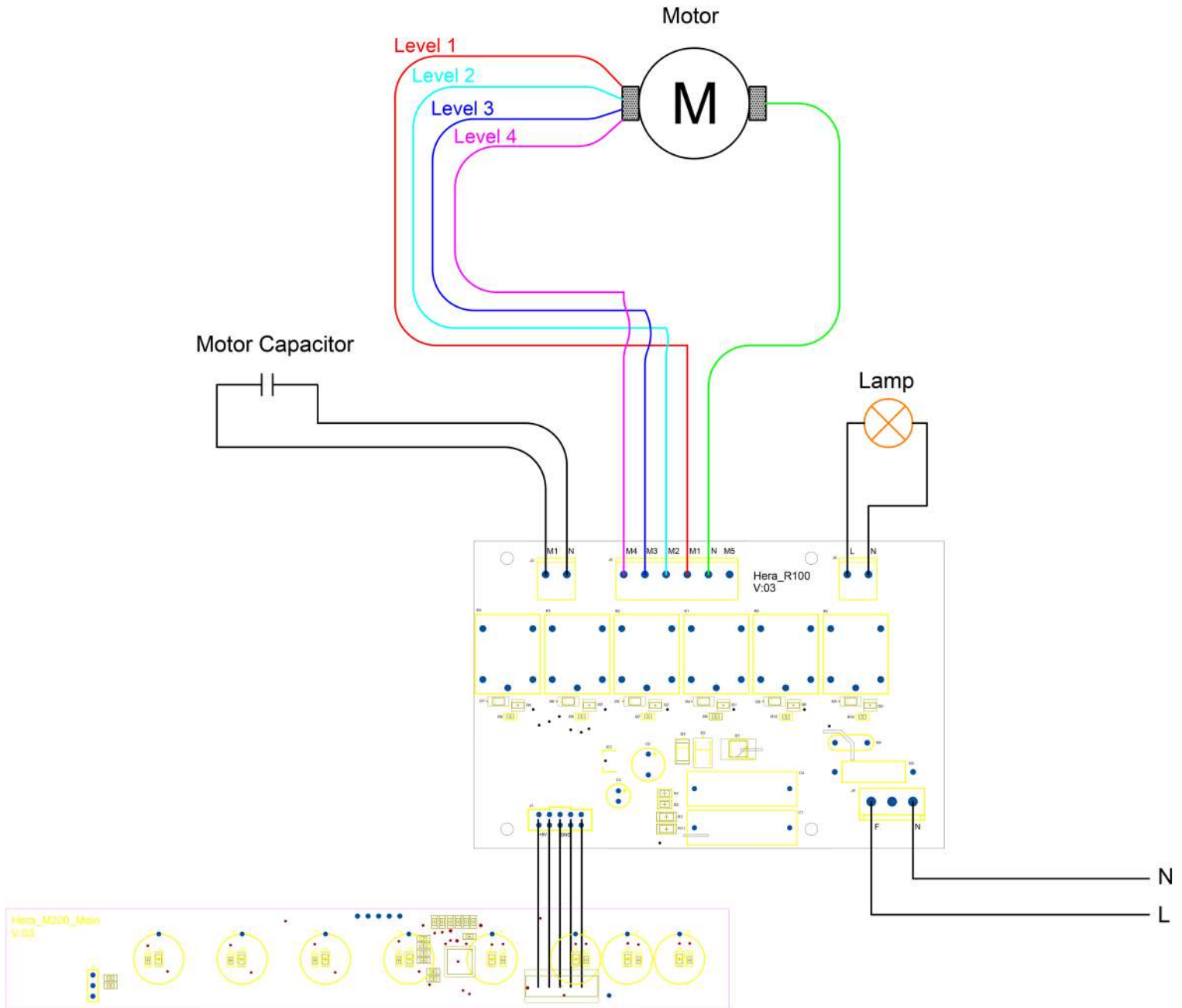

# Hera M200

## Range Hood Control Unit

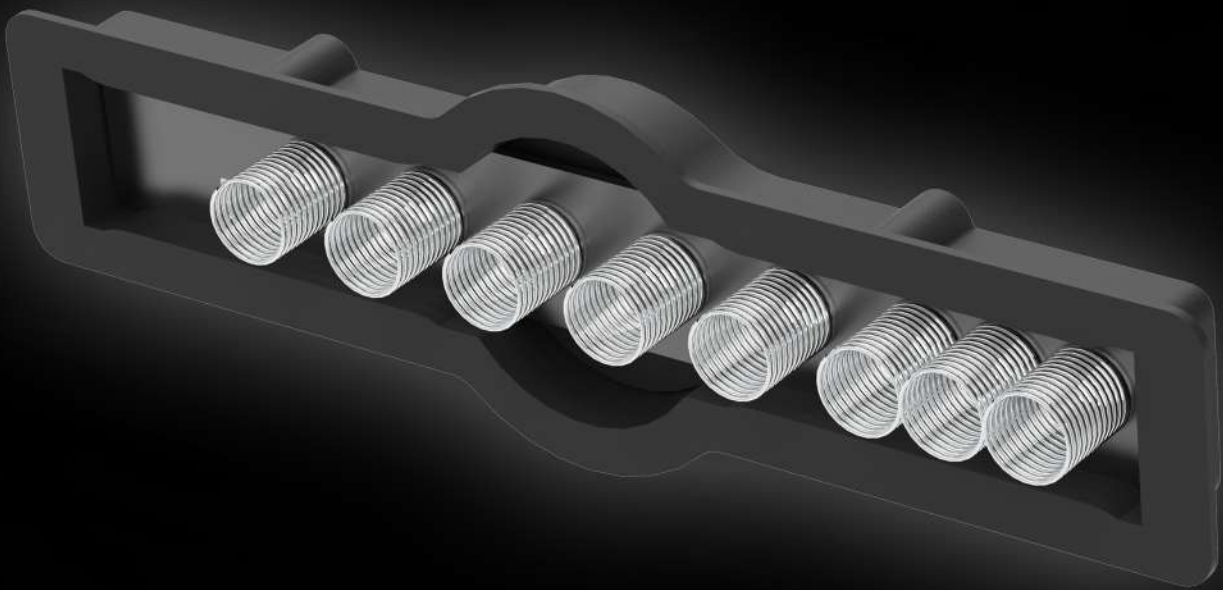

Factory Address: .....

Phone: .....

Fax: .....

E-Mail: .....

Webpage: .....

Document Version: .....

Hardware Version: .....

Software Version: .....