



Hera M300

Range Hood Control Unit

USER MANUAL



Manufacturer:

Phone:

Fax:

E-Mail:

Web:

Document Version:

Hardware Version:

Yazılım Versiyonu:

TABLE OF CONTENTS

1. GENERAL FEATURES

1.1. Product Specifications	4
1.2. Buttons and Their Functions	5

2. USAGE OF COOKER HOOD

6

3. USAGE OF LIGHT

6

4. 3D BOARD CASE VISUALS

7

6. ELECTRICAL WIRING DIAGRAM

8

1. GENERAL FEATURES

Hera M300 is a touch controlled, user-friendly cooker hood control unit.

With the touch buttons and custom design display, it brings an elegant look and a nice mood in the kitchen.

1.1. Product Specifications

- Custom Design Display
- Touch buttons
- 4 level settings
- Supply voltage 230V-50/60 Hz

1.2. Buttons and Their Functions



Turns on/off the cooker hood



Increase the hood level



Decrease the hood level





Turns on/off the light

2. USAGE of COOKER HOOD

To operate the hood, by pressing “” button hood becomes ready to use.

With the “” button the hood starts at level 1 and LightRings around the display starts to turn around in order to provide a nice visualisation.

With “” and “” buttons level can be set 1 to 4. The higher the level the LightRings turns faster to indicate level. When the level becomes 0 hood is stopped.

For stopping the hood while operating, the “” button is pressed and hold.

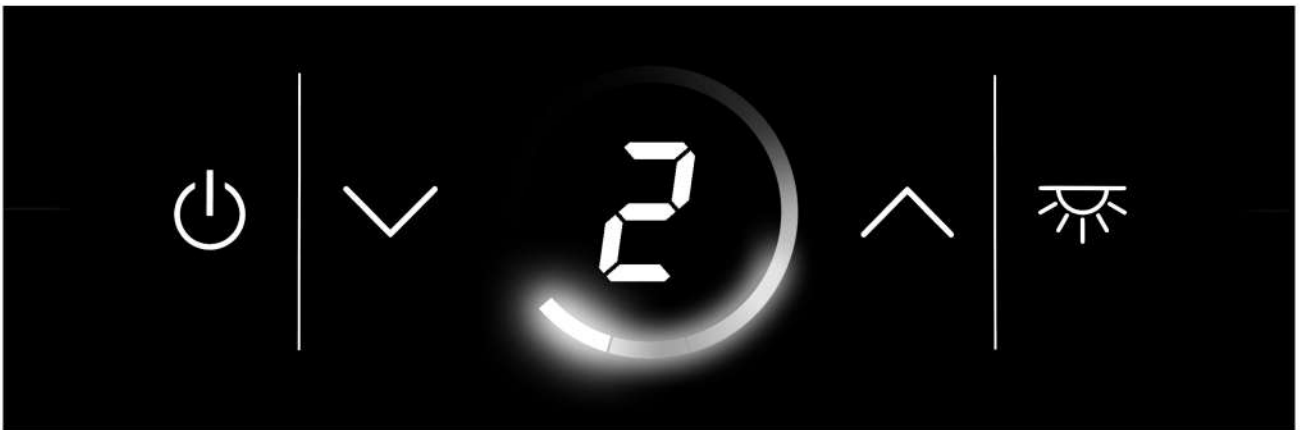

3. USAGE of LIGHT

The hood lighting lamp can be switched on and off independently of the use of the hood.

To turn the lighting lamp on or off, the “” button is pressed while the hood is running or not.

The light indicator led also stays on when the light is on.

4. 3D BOARD CASE VISUALS

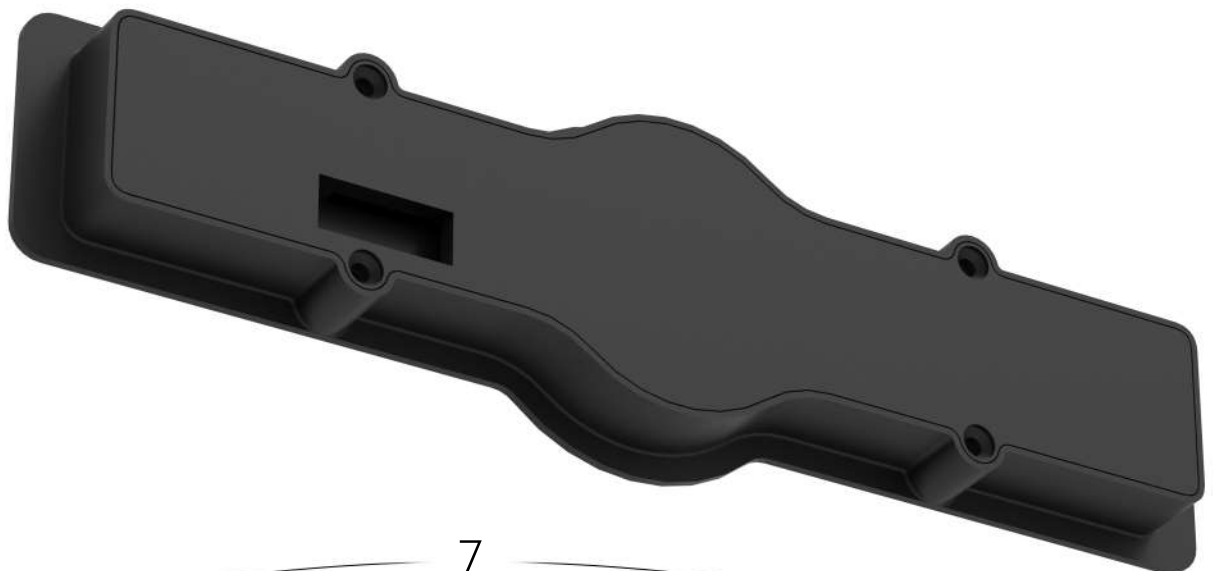

5. ELECTRICAL WIRING DIAGRAM

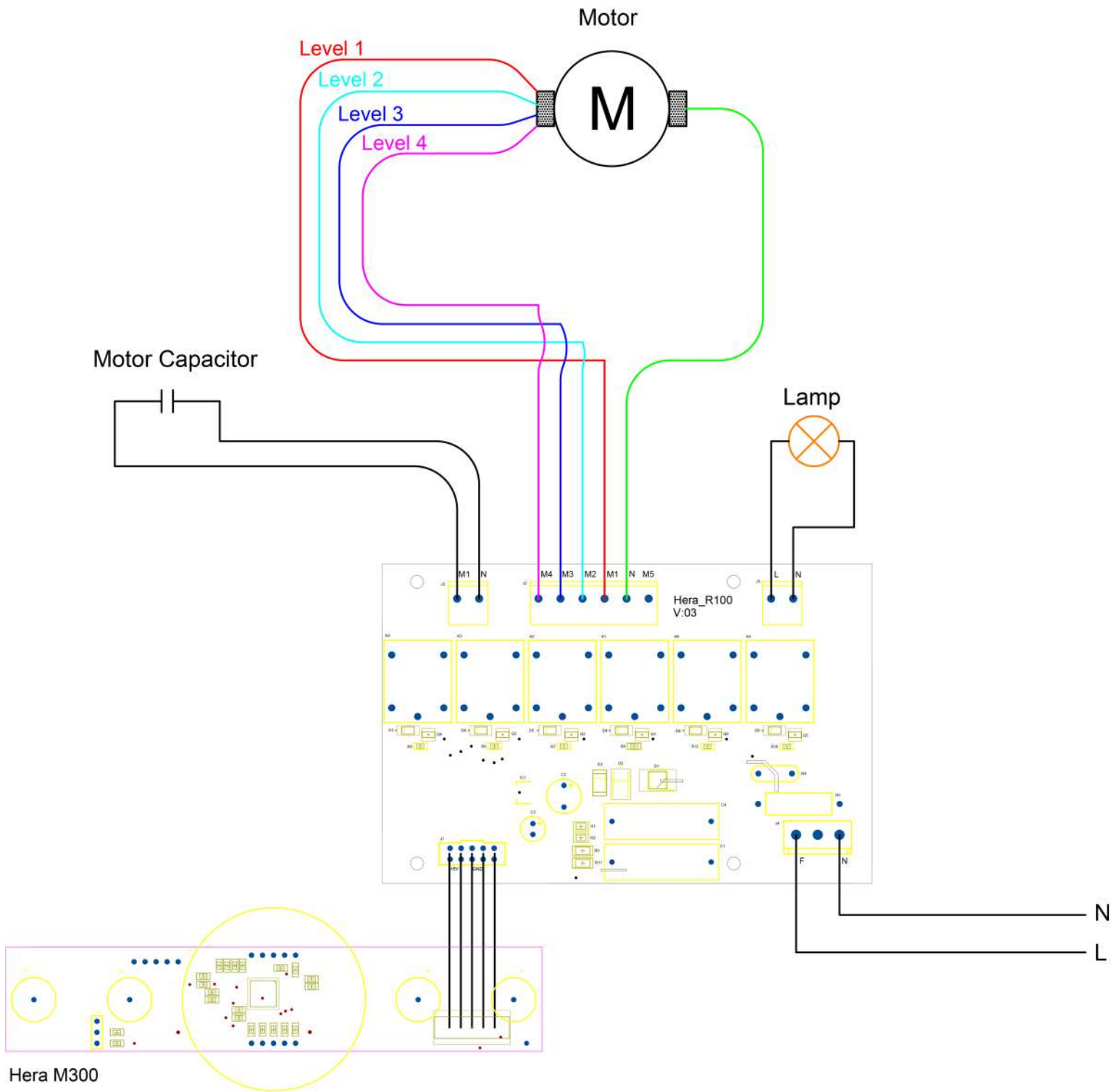

Hera M300

Range Hood Control Unit

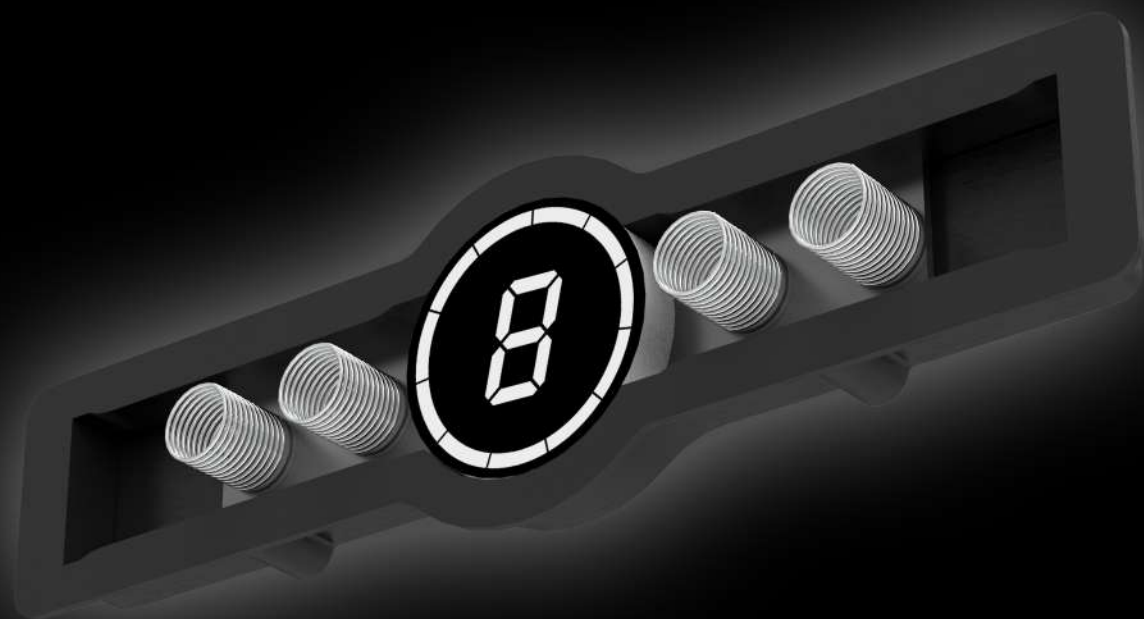

Factory Address:

Phone:

Fax:

E-Mail:

Webpage:

Document Version:

Hardware Version:

Software Version: